

Ertelt auf Grund des Ersten Überleitungsgesetzes vom 8. Juli 1949
(WIGBL. 5. 173)

BUNDESREPUBLIK DEUTSCHLAND



DEUTSCHES PATENTAMT
PATENTSCHRIFT

Nr. 829 406
KLASSE 57a GRUPPE 61
M 2073 IX a / 57 a

AUSGEGEBEN AM
24. JANUAR 1952

Erz. Ing. Gustav Boehme, Lüdenscheid (Westf.) und
Werner Warsawsky, Lüdenscheid (Westf.)
sind als Erfinder genannt worden

Zu der Patentschrift 829 406
Kl. 57a Gr. 61



Abb. 7

Zu der Patentschrift 829 406
Kl. 57a Gr. 61



a

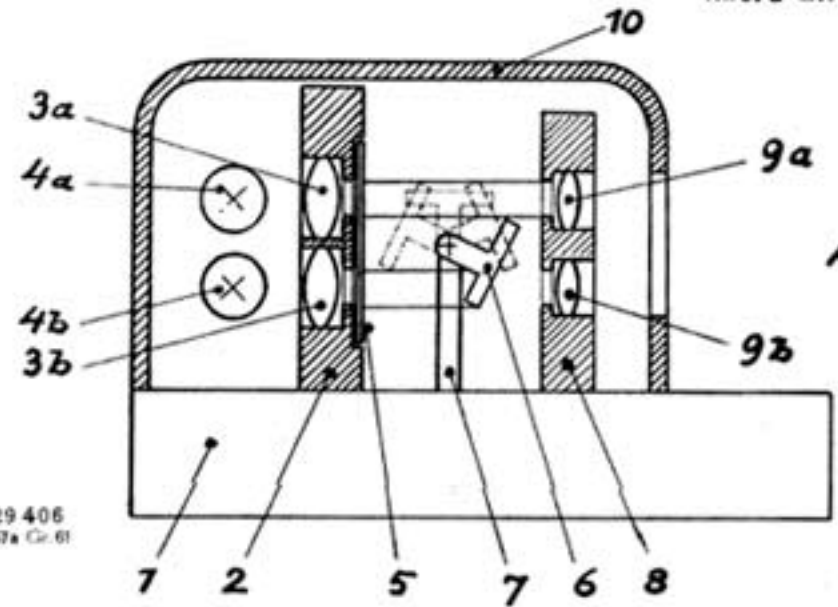
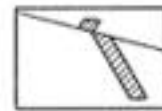

b

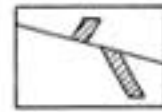

c

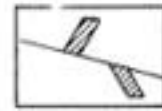

d



e



f



g

Abb. 5



Abb. 2



Abb. 3

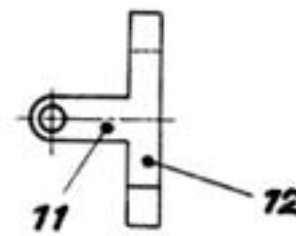
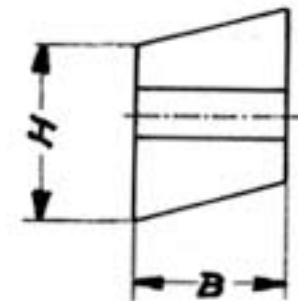
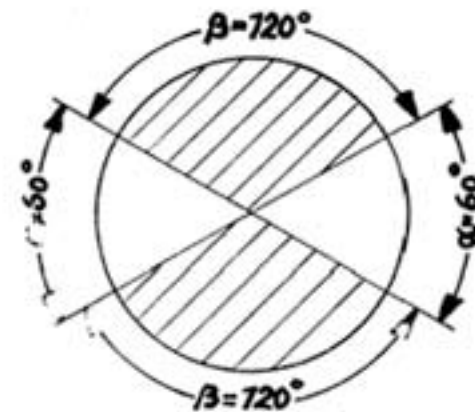

Abb. 4